

Inlet filter, PCB mounting, line switch 1-/2-pole

Standard- or Medical-Filter



new



C14



70° C



### Description

- Panel Mount:  
Screw-on mounting on PCB from rear-side
- 3 Functions:  
Inlet Protection class I, Line switch 1- or 2-pole, Line filter in standard and medical version
- For PCB mounting
- Alternative: version without line filter [DC21](#)

### Approvals

- VDE License Number: 40001522
- UL License Number: E72928

### Characteristics

- Ultra-compact design
- All single elements are already wired
- Line switch non-illuminated or illuminated
- With EMC-shield
- Especially suitable for use in switching power supplies  
Ideal for application with high transient loads
- Qualified for use in equipment according IEC/EN 60950

### Other versions on request

- Fixing on PCB with self-tapping screws 3 mm or pre-inserted nuts M3
- Other rocker marking
- Illuminated green
- Medical version M80
- Capacitance CX1

### References

[General Product Information](#)

### Weblinks

[Approvals](#), [RoHS](#), [CHINA-RoHS](#), [e-Store](#), [SCHURTER-Stock-Check](#), [Distributor-Stock-Check](#)

### Technical Data

Ratings IEC	1 - 10A @ Ta 40 °C / 250 VAC; 50Hz
Ratings UL/CSA	1 - 10A @ Ta 40 °C / 125 VAC; 60Hz
Leakage Current	standard < 0.5 mA (250 V / 60Hz) medical < 5 µA (250 V / 60 Hz)
Dielectric Strength	> 1.7 kVDC between L-N > 2.7 kVDC between L/N-PE Test voltage (2 sec)
Allowable Operation Temp.	-25 °C to 85 °C
Climatic Category	25/085/21 acc. to IEC 60068-1
Degree of Protection	from front side IP 40 acc. to IEC 60529
Protection Class	Suitable for appliances with protection class I acc. to IEC 61140
Terminal	For PCB mounting ; Ground terminal: Quick connect terminals 6.3 x 0.8 mm angled to pin axis
Panel Thickness s	Screw-on: max 4 mm Mounting screw torque max 0.5 Nm
Material: Housing	Thermoplastic, black, UL 94V-0

Appliance-Inlet /-Outlet	C14 acc. to IEC/EN 60320-1, UL 498 CSA C22.2 no. 42 (for cold condition) pin-temperature 70 °C, 10A, Protection class I
Line Switch	Rocker switch 1 or 2 pole, non-illumi- nated or illuminated red, acc. to IEC 61058-1 <a href="#">Technical details</a>
Line Filter	Standard and Medical Version, IEC 60939, IEC 60601-1, UL 1283, UL 544, EN 133 200, CSA C22.2 no. 8 <a href="#">Technical details</a>
MTBF	> 2'100'000h acc. to MIL-HB-217 F

**Dimensions**  
Screw-on mounting

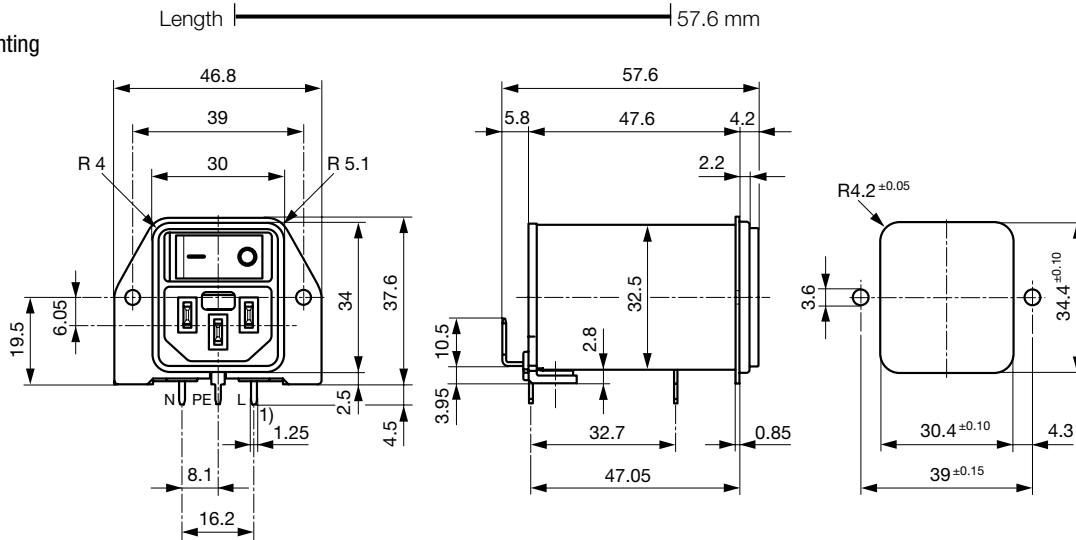

1) all pins

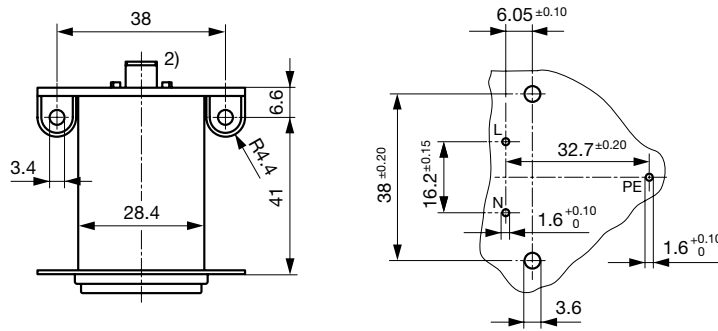

2) PE additionally as quick-connect terminal 6.3 x 0.8

**Technical Data of Filter-Components**

Rated Current [A]	Filter-Type	Inductances L [mH]	Capacitance CX [nF]	Capacitance CY [nF]	R [MΩ]
1	Standard Version	2 x 10	100	2.2	1
2	Standard Version	2 x 4	100	2.2	1
4	Standard Version	2 x 1.5	100	2.2	1
6	Standard Version	2 x 0.8	100	2.2	1
10	Standard Version	2 x 0.3	100	2.2	1
1	Medical Version (M5)	2 x 10	100	-	1
2	Medical Version (M5)	2 x 4	100	-	1
4	Medical Version (M5)	2 x 1.5	100	-	1
6	Medical Version (M5)	2 x 0.8	100	-	1
10	Medical Version (M5)	2 x 0.3	100	-	1

**Diagrams**

Standard filter 1-pole

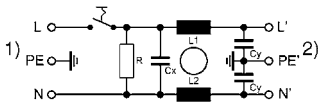

- 1) Line
- 2) Load

Standard filter 2-pole

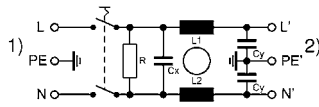

- 1) Line
- 2) Load

Medical filter 1-pole (M5)

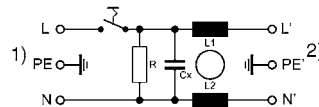

- 1) Line
- 2) Load

Medical filter 2-pole (M5)

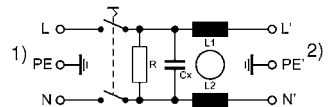

Standard filter 2-pole illuminated

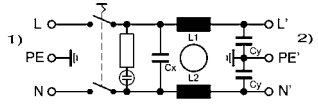

- 1) Line
- 2) Load

Medical Filter 2-pole (M5) illuminated

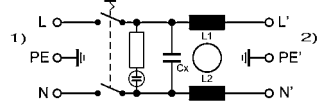

- 1) Line
- 2) Load

**Attenuation Loss**

Standard version

1 A

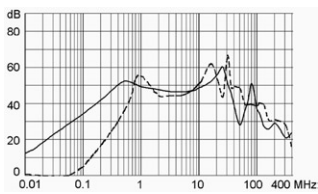

2 A

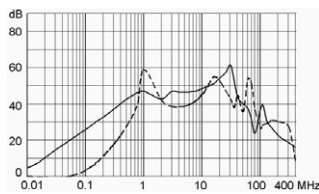

4 A

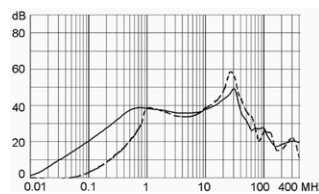

6 A

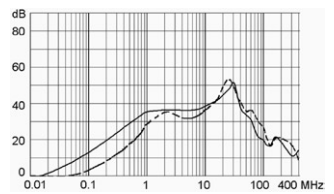

--- differential mode \_\_\_\_ common mode

10 A

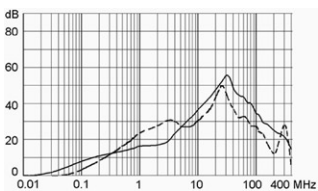

Medical version (M5)

1 A

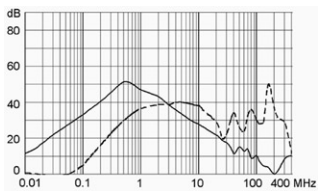

2 A

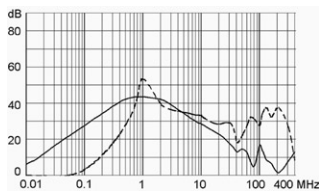

4 A

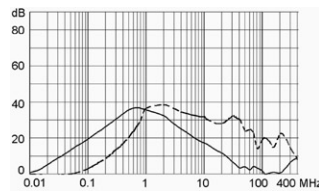

6 A

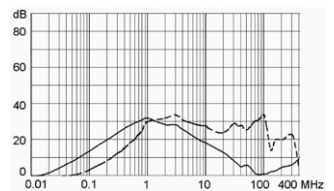

10 A

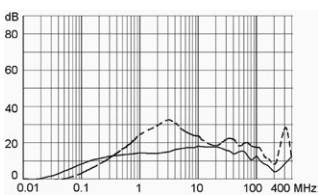

## Variants

Rated Current [A]	Filter-Type	Line Switch	Illumination	Color	Order Number
1	Standard Version	1 pole		-	DC22.1111.111
2	Standard Version	1 pole		-	DC22.2111.111
4	Standard Version	1 pole		-	DC22.4111.111
6	Standard Version	1 pole		-	DC22.6111.111
10	Standard Version	1 pole		-	DC22.9111.111
1	Standard Version	2-pole		-	DC22.1121.111
2	Standard Version	2-pole		-	DC22.2121.111
4	Standard Version	2-pole		-	DC22.4121.111
6	Standard Version	2-pole		-	DC22.6121.111
10	Standard Version	2-pole		-	DC22.9121.111
1	Standard Version	2-pole	●	red	DC22.1123.111
2	Standard Version	2-pole	●	red	DC22.2123.111
4	Standard Version	2-pole	●	red	DC22.4123.111
6	Standard Version	2-pole	●	red	DC22.6123.111
10	Standard Version	2-pole	●	red	DC22.9123.111
1	Medical Version (M5)	2-pole		-	DC22.1221.111
2	Medical Version (M5)	2-pole		-	DC22.2221.111
4	Medical Version (M5)	2-pole		-	DC22.4221.111
6	Medical Version (M5)	2-pole		-	DC22.6221.111
10	Medical Version (M5)	2-pole		-	DC22.9221.111
1	Medical Version (M5)	2-pole	●	red	DC22.1223.111
2	Medical Version (M5)	2-pole	●	red	DC22.2223.111
4	Medical Version (M5)	2-pole	●	red	DC22.4223.111
6	Medical Version (M5)	2-pole	●	red	DC22.6223.111
10	Medical Version (M5)	2-pole	●	red	DC22.9223.111

Packaging unit 10 Pcs

## Accessory

## Description



Cord retaining kits  
Cord retaining strain relieve

Flat head, G

4700.0007